

WI-FI SECURITY DIMMER SWITCH INSTALLATION GUIDE

SH-SD01



Thank you for purchasing your SECURAM smart home product. Our innovative products are designed to make your home safer, more convenient, and more energy-efficient. With the help of our easy-to-use app, you can control all of your SECURAM smart home devices from anywhere, at any time. Let's get started!

Contents

Title	Page No
Switch Overview	01
Installation	02 - 05
Download & Register	06 - 07
Pairing Your Switch	08
Switch Operation	09 - 10
Requirements, Specifications, Notices	11 - 12



WARNING: RISK OF ELECTRIC SHOCK OR FIRE.

Please follow all safety instructions on page two (2) and eleven (11) before installing, servicing, or removing your switch. If you're not familiar with basic electrical work, we recommend calling a **professional electrician** for installation.

What's in the Box



- Wi-Fi Security Dimmer Switch
- Faceplate
- 2 Screws
- Wire Labels
- Installation Guide

Getting started

- Turn OFF the power supply at the circuit breaker or fuse. Use a noncontact voltage tester to ensure that power is off. More than one disconnect switch may be needed to turn off power.
- Make sure the existing box has a neutral wire.

1 Switch Overview

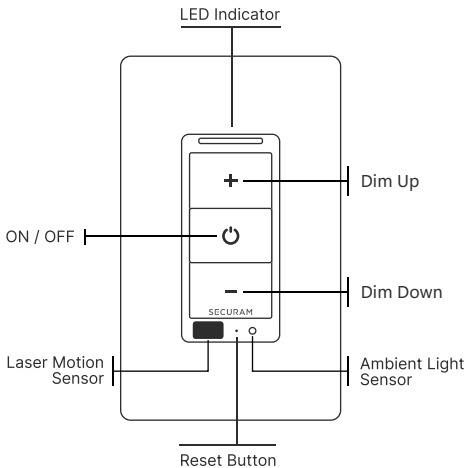

2 Install

STEP 1

Shut off power at the circuit breaker for the switch you are replacing. More than one disconnect switch may be required to turn off power. Use a noncontact voltage tester to ensure power is off.

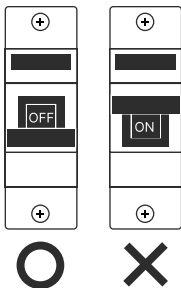

STEP 2

Make sure the existing switch box has a neutral wire*. Remove existing wall plate.

*Neutral wire is typically white.

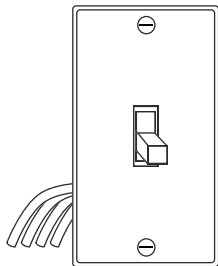

WARNING: RISK OF ELECTRIC SHOCK OR FIRE.

3 Install

STEP 3

Turn on the power at the circuit breaker and use a noncontact voltage tester to check which wire is live (line). The tester will flash or chirp when it comes close to a line wire. Turn off the power at the circuit breaker and label the wires. Remove the old switch by disconnecting all wires.

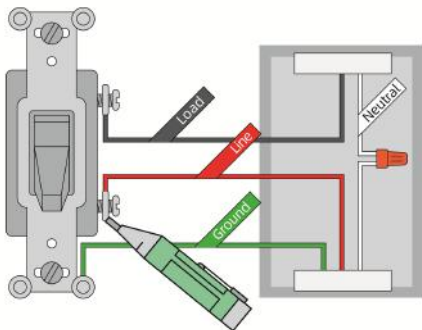

4 Install

STEP 4

Follow the wiring diagram to connect the wires in the wall box to the switch. Insert the wire into the connector hole of the switch, and use the screwdriver to fasten it firmly. Or you can connect the switch wires to the wires in the wall box with the wire nuts.

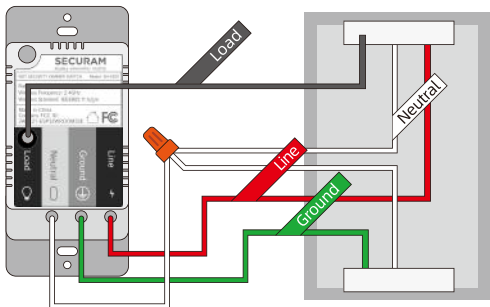

5 Install, cont.

STEP 5

Use screws to secure Switch into your wall. Then, snap on included faceplate.

STEP 6

Restore power by turning on the breaker.

STEP 7

Once power is connected, the LED indicator will blink blue to indicate it is ready to connect to Wi-Fi.

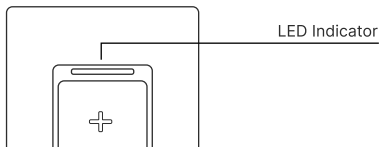
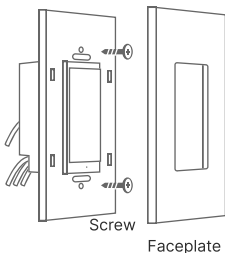

6

Download the SECURAM Guard app



7 Register SECURAM Guard account

Create an account

Email

Email Phone

By creating an account, I've read and agreed to [User Agreement and Privacy Policy](#)

Create Account

STEP 1

Enter your email address or mobile phone number.

Create an account

Enter verification code

Didn't get it? [Check your spam or junk email folder.](#) [Check your mobile number.](#)

[Resend code!](#)

Submit

STEP 2

Enter the verification code.

Create an account

Password (8-16 characters long)

Confirm password

Submit

STEP 3

Create a password.

Login Email Phone

Email

Password

Keep me logged in [Forgot password?](#)

Log in

Facial recognition will be available after logging in with account and password.

STEP 4

Log into the app.

8

Pairing Your Switch

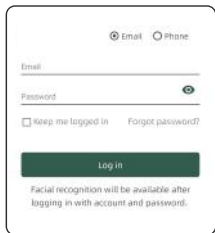

STEP 1

Log into the app.



STEP 2

Tap + to add your device.



STEP 3

Select WIFI SWITCH.

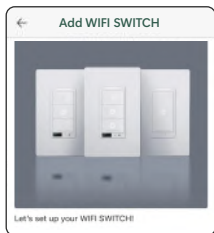

STEP 4

Follow the step-by-step in app guide.

9

LED Indicator Status

LED Indicator	Switch Status
Blinking Blue	Device in pairing mode
Blinking Red	Device network disconnected
Blinking Orange	Home Security System is armed
Rapid Blinking Orange	Motion detected when armed
Solid White	Device working normally
Off	No motion detected, or switch has no power

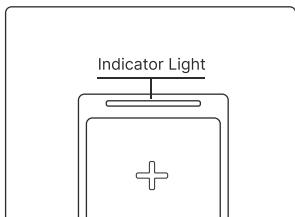

10 Button Operation

ON / OFF

This button toggles the wired light on and off.

Dim Up

This button raises the brightness of the light. Press to raise the brightness incrementally. Press and hold to gradually raise the brightness.

Dim Down

This button lowers the brightness of the light. Press to lower the brightness incrementally. Press and hold to gradually lower the brightness.

Reset Button

To reboot switch: Press the button once.

To factory reset: Press and hold until all LEDs turn on. The LED indicator will begin to blink blue, indicating the switch has been reset.

Warnings

- Install only in a suitable UL Listed outlet box.
- CAUTION - Risk of Electric Shock - More than one disconnect switch may be required to de-energize the equipment before servicing.
- Tighten terminal screws to 13 lbf-in / 7.5kgf-cm.
- Supported specified line number for the thread terminal copper wire: 12AWG and 14AWG.

Requirements

- Neutral Wire
- Single Pole with >2" deep box
- 2.4GHz Wi-Fi network (5GHz Wi-Fi is not supported)
- SECURAM Guard App
- Phone with iOS 9.0 or later, or Android 8.0 or later

Specifications

- Rating: 100-120VAC 60Hz
- Supported Load Types:
 - 100-120V~ 3A, Incandescent
 - 100-120V~ 3A, Electronic Fluorescent Ballast
 - 100-120V~ 1.5A, LED
- Wireless Frequency: 2.4 GHz
- Wireless Standard: IEEE802.11 b/g/n
- Operating Temperature: 32°F-104°F (0 °C-40 °C)
- Operating Humidity: 5%-85%RH, Non-condensing
- Size: 2.91" x 1.69" x 4.69" (LxWxH)
- Container FCCID: 2ACZ7-ESP32WROOM32E

Children Safety

This device and its accessories may contain small parts. Please keep them out of reach of children.

Remember, this device is not a toy. Children should only use it under adult supervision.

Be sure to keep it away from children and pets.

FCC Notice

This device complies with part 15 of the FCC Rules. Operation is subject to the following two conditions: (1) this device may not cause harmful interference, and (2) this device must accept any interference received, including interference that may cause undesired operation. Any changes or modifications not expressly approved by the party responsible for compliance could void the user's authority to operate the equipment.

NOTE: This equipment has been tested and found to comply with the limits for a Class B digital device, pursuant to Part 15 of the FCC Rules. These limits are designed to provide reasonable protection against harmful interference in a residential installation. This equipment generates, uses and can radiate radio frequency energy and, if not installed and used in accordance with the instructions, may cause harmful interference to radio communications. However, there is no guarantee that interference will not occur in a particular installation. If this equipment does cause harmful interference to radio or television reception, which can be determined by turning the equipment off and on, the user is encouraged to try to correct the interference by one or more of the following measures:

- Reorient or relocate the receiving antenna.
- Increase the separation between the equipment and receiver.
- Connect the equipment into an outlet on a circuit different from that to which the receiver is connected.
- Consult the dealer or an experienced radio/TV technician for help.

The device has been evaluated to meet general RF exposure requirements.

The device can be used in portable exposure condition without restriction.

Contains FCC ID: 2ACZ7-ESP32WROOM32E

We are here to help.

Contact us if you have any questions, or
need assistance with our products.



support.securamsys.com

+1 (805) 988-8088



SECURAM